

WOHNÜBERBAUUNG WOLFGANGHOF SÜD

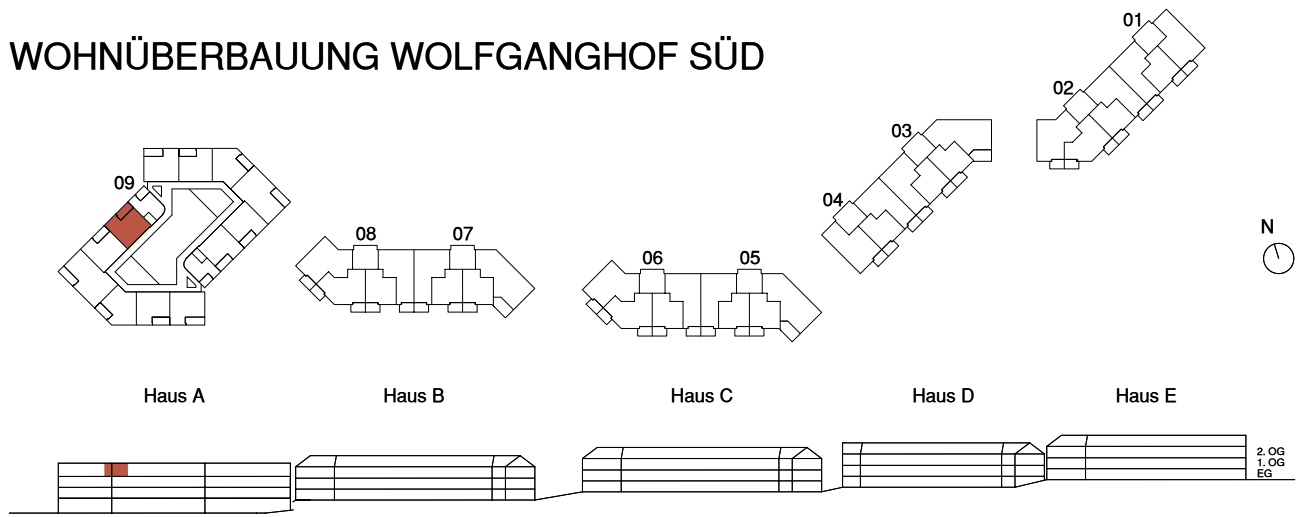

Adresse
Wolfgangstrasse 80, 9014 St. Gallen

Haus A

Stockwerk
3. Obergeschoss

Wohnung
09.3013

Anzahl Zimmer
2.5

Nettowohn-/ Balkonfläche
53.7 m² / 8.2 m²

